

# User Manual

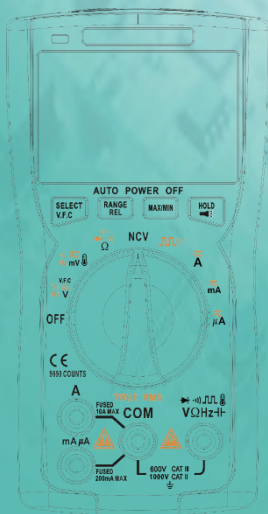

## LIMITED WARRANTY AND LIMITATION OF LIABILITY

Customers enjoy one-year warranty from the date of purchase.

This warranty does not cover fuses, disposable batteries, damage from misuse accident, neglect, alteration, contamination, or abnormal conditions of operation or handling, including failures caused by use outside of the product's specifications, or normal wear and tear of mechanical components.

# Table of Contents

# Page

Introduction.....	1
Safety Information.....	1
Instrument Overview.....	3
LCD Display.....	3
Function Buttons.....	5
Rotary Buttons.....	6
Input Terminals.....	8
Measurements Instruction.....	9
Measure AC/DC Voltage.....	9
Measure AC/DC Current.....	9
Measure Resistance.....	10
Test Diodes and Continuity.....	10
Measure Capacitance.....	11
Measure Frequency and Duty Cycle.....	12
Measure Temperature.....	13
Test NCV.....	13

V.F.C test.....	14
Square wave test.....	14
Maintenance.....	15
Clean the Product.....	15
Replace the Batteries.....	15
Replace the Fuses.....	16
Specifications.....	17
General Specifications.....	17
Mechanical Specifications.....	17
Environmental Specifications.....	17
Electrical Specifications.....	18

## Introduction

This product is a 9999 counts true RMS auto-ranging digital multimeter.

## Safety Information

To avoid possible electrical shock, fire, or personal injury, please read all safety information before you use the product. Please use the product only as specified, or the protection supplied by the product can be compromised.

- Examine the case before you use the product. Look for cracks or missing plastic. Carefully look at the insulation around the terminals.
- The measurement must be made with correct input terminals and functions and within the allowable measuring range.
- Do not use the product around explosive gas, vapor, or in damp or wet environments.



- Keep fingers behind the finger guards on the probes.
- When the product has already been connected to the line being measured, do NOT touch the input terminal that is not in service.
- Disconnect the test leads from the circuit before changing the mode.
- When the voltage to be measured exceeds 36V DC or 25V AC, the operator shall be careful enough to avoid electric shock.
- Misuse of mode or range can lead to hazards, be cautious. “OL” will be shown on the display when the input is out of range.
- Low level of a battery will result in incorrect readings. Change the batteries when battery level is low. Do not make measurements when the battery door is not properly placed.

# Instrument Overview

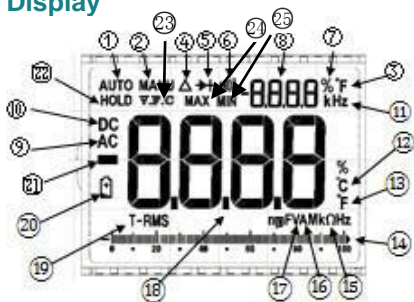
## LCD Display



①	<b>AUTO</b>	Auto range. The product selects the range with the best resolution.
②	<b>MANU</b>	Manual range. The user selects the range.
③	<b>F</b>	Capacitance test. (Farad)
④	<b>Δ</b>	Relative mode.
⑤	<b>→ </b>	Diode test.
⑥	<b>•))</b>	Continuity test.
⑦	<b>%</b>	Duty cycle test.
⑧	<b>-8888</b>	Secondary measurements display.
⑨	<b>AC</b>	Alternating current.
⑩	<b>DC</b>	Direct current.

⑪	<b>Hz</b>	Frequency test. (Hertz)
⑫	<b>°C</b>	Temperature test. (Celsius)
⑬	<b>°F</b>	Temperature test. (Fahrenheit)
⑭		Analog bar graph.
⑮	<b>Ω</b>	Resistance test. (Ohm)
⑯	<b>A</b>	Current test. (Ampere)
⑰	<b>V</b>	Voltage test. (Volt)
⑱	<b>-8888</b>	Primary measurement display.
⑲	<b>T-RMS</b>	The product measures both sinusoidal and nonsinusoidal ac waveforms accurately.
⑳		Low battery. Replace batteries.
㉑		Negative readings.
㉒	<b>HOLD</b>	Display freezes present reading.
㉓	V.F.C	Frequency converter test.
㉔	<b>MAX</b>	Display maximum value.
㉕	<b>MIN</b>	Display minimum value.
<b>nkMmm</b>		Measurement units.



## Function Buttons

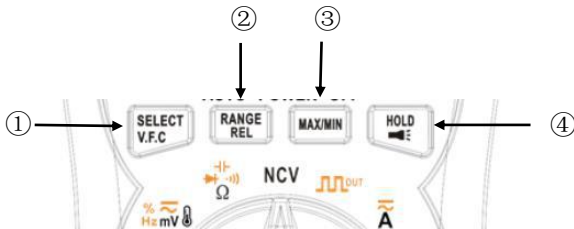

①	Short press to switch among functions. Long press to enter in V.F.C function.
②	Short press to change range. Push for more than 2 seconds to enter the relative mode. The product will store the present reading as a reference for subsequent readings. The display is zeroed, and the stored reading is subtracted from all subsequent readings. Long-push again to exit the relative mode.
③	Press this button to switch MAX/MIN test. Long press 2 second to quit MAX/MIN mode.
④	Push once to hold the current reading on the display; push again to continue normal operation. Long press beyond 2 seconds to turn on flashlight ; long press again to turn off flashlight.



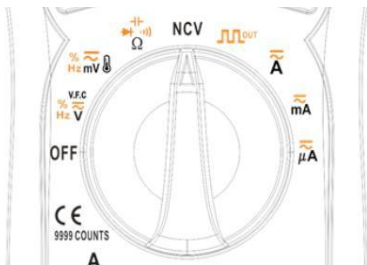





## Rotary button



**OFF**

Turn off the product at this position.

- The product automatically powers off after 15 minutes of inactivity.
- The built-in beeper beeps 5 times 1 minute before auto power off.
- To restart the product from auto power off, press the SELECT button or turn the rotary switch back to the OFF position and then to a needed position.
- To disable the Auto Power Off function, hold down the SELECT button when turning on the product, you will hear five beeps if you have successfully disabled the function.

	<p>AC voltage <math>\leq 750V</math>  DC voltage <math>\leq 1000V</math>  Frequency <math>\geq 10V</math>, 1~100KHz  Duty cycle: 1%~99%  V.F.C</p>
	<p>AC voltage <math>\leq 99.99mV</math>  DC voltage <math>\leq 99.99mV</math>  Frequency <math>\leq 10V</math>, 1~10MHz  Duty cycle : 1%~99%  Temperature: -20~1000° C (-4~1832)°F</p>
	<p>Resistance: <math>\leq 99.99M\Omega</math>  Continuity: beeper will beep when resistance less than 50 <math>\Omega</math>  Diode test. Displays  above 3V  Capacitance: <math>\leq 9.999mF</math></p>
<p>NCV</p>	<p>NCV</p>
	<p>Square wave:  50Hz/100Hz/200Hz/300Hz/400Hz/  500Hz/600Hz/700Hz/800Hz/900Hz/  1000Hz/2000Hz/3000Hz/4000Hz/  5000Hz</p>
	<p>DC current: <math>\leq 99.99mA</math>.  AC current: <math>\leq 99.99mA</math>.</p>
	<p>DC current: <math>\leq 999.9\mu A</math>.  AC current: <math>\leq 999.9\mu A</math>.</p>
	<p>DC current: <math>\leq 9.999A</math>  AC current: <math>\leq 9.999A</math></p>

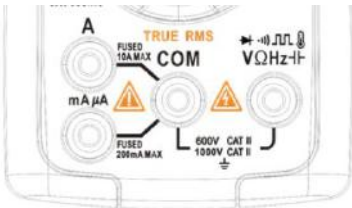

## Input Terminals



A	Input terminal for AC/DC current measurements to 9.999A.
$\mu A/mA$	Input terminal for AC/DC current measurements to 99.99mA.
COM	Common (return) terminal for all measurements.
	Input terminal for the measurements of: <ol style="list-style-type: none"> <li>1. Diode</li> <li>2. Continuity</li> <li>3. Square wave</li> <li>4. Temperature</li> <li>5. AC/DC voltage</li> <li>6. Resistance</li> <li>7. Frequency</li> <li>8. Capacitance</li> </ol>

# Measurements Instruction



## Measure AC/DC Voltage

1. Connect the black test lead to the COM Terminal and the red lead to the  Terminal.
2. To measure voltage under 99.99mV, turn the rotary to  .To measure voltage higher than 99.99mV, turn the rotary to  , press SELECT to turn to AC voltage test mode.
3. Touch the probes to the correct test points of the circuit to measure the voltage.
4. Read the measured voltage on the screen.

**\*Do not measure voltage that exceeds the extremes as indicated in the Specifications.**

**\*Do not touch high voltage circuit during measurements.**

## Measure AC/DC Current



1. Connect the black test lead to the COM Terminal and the red lead to the  $\mu\text{A}$  or mA Terminal (choose based on the value of the current to be measured);
2. Turn the rotary to  ,  or  ;
3. Break the circuit path to be measured, connect the test leads across the break and apply power;
4. Read the measured current on the display.

**\*Do not measure current that exceeds the extremes as indicated in the Specifications.**

**\*Use the AmA Terminal when you are measuring an unknown current. Then switch to the  $\mu$ A Terminal if necessary.**

**\*Do not input voltage at this setting.**



## Measure Resistance

1. Connect the black test lead to the COM Terminal and the test lead to the  Terminal;
2. Turn the rotary to  , press “SELECT” to the Resistance Mode. The screen will show “  ”;
3. Touch the probes to the desired test points of the circuit to measure the resistance;
4. Read the measured resistance on the display.

**\*Disconnect circuit power and discharge all capacitors before you test resistance.**

**\*Do not input voltage at this setting.**

## Test Diodes and Continuity



1. Connect the black test lead to the COM Terminal and the red lead to the  Terminal;
2. Turn the rotary to  , press “SELECT” to the continuity Mode;
3. To test continuity, touch the probes to the desired test points of the circuit. The built-in beeper will beep when there is a short circuit;

4. To test diodes, connect the red probe to the anode side and the black probe to the cathode side of the diode being tested. Then read the forward bias voltage value on the display. If the polarity of the test leads is reversed with diode polarity or the diode is broken, the display reading shows “OL”.

**\*Do not input voltage at this setting.**



**\*Disconnect circuit power and discharge all capacitors before you test diode.**

## Measure Capacitance

1. Connect the black test lead to the COM Terminal and the red lead to the  Terminal;
2. Turn the rotary to  , press “SELECT” to the capacitance Mode;
3. Connect the red probe to the anode side and the black probe to the cathode side of the diode being tested;
4. Read the measured capacitance value on the display once the reading is stabilized.



**\*Disconnect circuit power and discharge all capacitors before you test diode.**

## Measure Frequency and Duty Cycle

1. Connect the black test lead to the COM Terminal and the red lead to the  Terminal;
2. Turn the rotary switch to , press SELECT to frequency test function ( $\geq 10V$  , 1~100KHz); or turn the rotary switch to , press SELECT to frequency test function ( $\leq 10V$  , 1~5MHz);
3. If the frequency between 100kHz and 5MHz, press SELECT to enter AC mV position. Touch the probes to the desired test points, now the vice display will show frequency; Then press the SELECT again, the main display will show frequency and vice display will show duty cycle.



## Measure Temperature



1. Connect the black test lead to the COM Terminal and the red lead to the  Terminal;
2. Turn the rotary to  press “SELECT” to the temperature Mode; Now the main display will show Celsius and the vice display will show Fahrenheit;
3. Touch the probes to the desired test points;
4. Read the measured temperature on the display.

**\*Do not input voltage at this setting.**



## Test NCV

1. Turn the rotary to NCV position, press “SELECT” to the temperature Mode;
2. Hold the product and move it around, the built-in beeper will beep when the inner sensor detects AC voltage nearby. The stronger the voltage is, the quicker the beeper beeps.

## Measure V.F.C

1. Connect the black test lead to the COM Terminal and the red lead to the  Terminal;
2. Turn the rotary to , long press  to enter V.F.C mode, the screen will show voltage when put the test leads at the correct circuit.

## Measure square wave

1. Connect the black test lead to the COM Terminal and the red lead to the  Terminal;
2. Turn the rotary switch to  , and the default output frequency is 50Hz. To change the output frequency, press the SEL button.
3. Touch the probes to the desired test points.

**\*Do not input voltage at this setting.**

## Maintenance

Beyond replacing batteries and fuses, do not attempt to repair or service the product unless you are qualified to do so and have the relevant calibration, performance test, and service instructions.

### *Clean the Product*

Wipe the product with a damp cloth and mild detergent. Do not use abrasives or solvents. Dirt or moisture in the terminals can affect readings.

\*Remove the input signals before you clean the product.

### *Replace the Batteries*

When “” is shown on the display, batteries shall be replaced as below:

1. Remove the test leads and turn off the product before replacing the batteries.

2. Loosen the screw on the battery door and remove the battery door.
3. Replace the used batteries with new batteries of the same type.
4. Place the battery door back and fasten the screw.

### ***Replace the Fuses***

When a fuse is blown or do not work properly, it shall be replaced as below:

1. Remove the test leads and turn off the product before replacing the fuse.
2. Loosen the four screws on the back cover and the screw on the battery door, then remove the battery door and the back cover.
3. Replace the fuse with a new fuse of the same type.
4. Place the back cover and the battery door back and fasten the screws.

## Specifications

<b>General Specifications</b>	
Display (LCD)	9999 Counts
Ranging	Auto/Manual
Material	ABS+TPE
Update Rate	3 Times/Second
Ture RMS	√
Data Hold	√
Backlight	√
Low Battery Indication	√
Auto Power Off	√

<b>Mechanical Specifications</b>	
Dimension	147*76*37mm
Weight	191g (without batteries)
Battery Type	1.5V AAA Battery * 3
Warranty	One year

<b>Environmental Specifications</b>		
Operating	Temperature	0~40°C
	Humidity	<75%
Storage	Temperature	-20~60°C
	Humidity	<80%

## Electrical Specifications

<i>Function</i>	<i>Range</i>	<i>Resolution</i>	<i>Accuracy</i>
DC Voltage (V)	999.9mV	0.1mV	$\pm(0.5\%+3)$
	9.999V	0.001V	
	99.99V	0.01V	
	999.9V	0.1V	
DC Voltage (mV)	9.999mV	0.001mV	
	99.99mV	0.01mV	
AC Voltage (V)	999.9mV	0.1mV	$\pm(1.0\%+3)$
	9.999V	0.001V	
	99.99V	0.01V	
	750.0V	0.1V	
AC Voltage (mV)	9.999mV	0.001mV	
	99.99mV	0.01mV	
*Frequency response of ACV: 40Hz-1kHz			

Function	Range	Resolution	Accuracy	
DC Current (A/mA)	9.999A	0.001A	$\pm(1.0\%+3)$	
	999.9mA	0.1mA		
DC Current ( $\mu$ A/mA)	99.99mA	0.01mA		
	9.999mA	0.001mA		
	99.99 $\mu$ A	0.01 $\mu$ A		
	999.9 $\mu$ A	0.1 $\mu$ A		
AC Current (A/mA)	9.999A	0.001A		$\pm(1.2\%+3)$
	999.9mA	0.1mA		
AC Current ( $\mu$ A/mA)	99.99mA	0.01mA		
	9.999mA	0.001mA		
	99.99 $\mu$ A	0.01 $\mu$ A		
	999.9 $\mu$ A	0.1 $\mu$ A		
Frequency response of AC Current: 40Hz-1kHz				

Function	Range	Resolution	Accuracy
Resistance	99.99 $\Omega$	0.01 $\Omega$	$\pm(1.0\%+3)$
	999.9 $\Omega$	0.1 $\Omega$	$\pm(0.5\%+3)$
	9.999k $\Omega$	0.001k $\Omega$	
	99.99k $\Omega$	0.01k $\Omega$	
	999.9k $\Omega$	0.1k $\Omega$	$\pm(1.5\%+3)$
	9.999M $\Omega$	0.001M $\Omega$	
	99.99M $\Omega$	0.01M $\Omega$	$\pm(3.0\%+5)$
Capacitance	9.999nF	0.001nF	$\pm(5.0\%+20)$
	99.99nF	0.01nF	$\pm(2.0\%+5)$
	999.9nF	0.1nF	
	9.999 $\mu$ F	0.001 $\mu$ F	
	99.99 $\mu$ F	0.01 $\mu$ F	
	999.9 $\mu$ F	0.1 $\mu$ F	$\pm(5.0\%+5)$
	9.999mF	0.001mF	



Function	Range	Resolution	Accuracy
Frequency (Measures only to 100kHz under the ACV setting)	9.999Hz	0.001Hz	$\pm(0.1\%+2)$
	99.99Hz	0.01Hz	
	999.9Hz	0.1Hz	
	9.999kHz	0.001kHz	
	99.99kHz	0.01kHz	
	999.9kHz	0.1kHz	
	5.000MHz	0.001MHz	
Duty Cycle	1%~99%	0.1%	$\pm(0.1\%+2)$
Temperature	(-20~1000) $^{\circ}\text{C}$	1 $^{\circ}\text{C}$	$\pm(2.5\%+5)$
	(-4~1832) $^{\circ}\text{F}$	1 $^{\circ}\text{F}$	
Diode	√		
Continuity	√		
NCV	√		
Square wave	√		
V.F.C	√		

