

**UNI-T®**

**Model UT511  
OPERATING MANUAL**

TITLE	PAGE
Introduction	5
Unpacking the Meter	5
Safety Information	5
International Electrical Symbols	7
Battery Saver (Sleep Mode)	8
Battery Indication	8
The Meter Structure	9
Display	10
Key Functions	12
<b>Measurement Operation</b>	15
A.Measuring Voltages	15
B.Measuring Insulation Resistance	16
a) Continuous Measurement	17
b) Timed Measurement	18
c) Polarization Index (PI) Measurement	18
d) Compare Function	19
C. Low Resistance Measurement	20

TITLE	PAGE
The Use of Power Adaptor .....	21
<b>Maintenance</b> .....	22
A. General Service .....	22
B. Replacing the Battery .....	22
<b>Specifications</b> .....	24
Safety and Compliances .....	24
Physical Specifications .....	24
General Specifications .....	25
Feature Summary .....	25
Detailed Accuracy Specifications .....	26
A. Voltage Measurement .....	26
B. Insulation Resistance Measurement .....	26
C. Low Resistance Measurement .....	27

<b>Table</b>	<b>Title</b>	<b>Page</b>
1.	Unpacking Inspection -----	5
2.	International Electrical Symbols -----	7
3.	Battery Indication -----	8
4.	Meter Front Description -----	9
5.	Meter Side Description -----	10
6.	Display Description -----	11
7.	Key Description -----	12

<b>Figure</b>	<b>Title</b>	<b>Page</b>
1.	The Meter Front Structure -----	9
2.	The Meter Side Structure -----	10
3.	The Display -----	10
4.	Voltage Measurement -----	15
5.	Insulation Resistance Measurement -----	16
6.	Low Resistance Measurement -----	20
7.	The Use of Power Adaptor -----	21
8.	Battery Replacement -----	23

## Model UT511: OPERATING MANUAL

### Introduction

Uni-Trend Model UT511 insulation resistance tester (hereafter, “the Meter”) is a handheld instrument designed primarily to make resistance/ insulation resistance measurement.

### Unpacking the Meter

The Meter includes the following items:

Table 1. Unpacking Inspection

Item	Description	Qty
1	English Operating Manual	1 piece
2	One plug test lead to one alligator	2 pieces
3	Two plugs test lead to one alligator	1 piece
4	1.5V Battery (R14 or LR14)	8 pieces
5	Tool Box	1 piece
6	Power adaptor (optionally, available at extra cost)	1 piece

In the event you find any missing or damage, please contact your dealer immediately.

### Safety Information

This Meter complies with the standards IEC61010 safety measurement requirement: in pollution degree 2, overvoltage category (CAT. III 600V, CAT.II 1000V) and double insulation.

CAT II: Local level, appliance, PORTABLE EQUIPMENT etc., with smaller transient voltage overvoltages than CAT. III

CAT III: Distribution level, fixed installation, with smaller transient overvoltages than CAT. IV

Use the Meter only as specified in this operating manual, otherwise the protection provided by the Meter may be impaired.

 **Danger** identifies conditions and actions that pose hazard(s) to the user.

 **Warning** identifies avoiding electric shock.

 **Caution** identifies conditions and actions that may damage the Meter and carrying out accurate measurement.

International electrical symbols used on the Meter and in this Operating Manual are explained on page 4~5.

### **Danger**

**Use of instrument in a manual not specified by the manufacturer may impair safety features/protection provided by the equipment. Read the following safety information carefully before using or servicing the instrument.**

- 1 **Do not apply more than 1000VDC or 750V AC.**
- 1 **Do not use the Meter around explosive gas, vapor or dust.**
- 1 **Do not use the Meter in a wet environment.**
- 1 **When using the test leads, keep your fingers away from the lead contacts. Keep your fingers behind the finger guards on the leads.**
- 1 **Do not use the Meter with any parts or cover removed.**
- 1 **When carrying out insulation measurement, do not contact the circuit under test.**

### **Warning**

- 1 **Do not use the Meter if it is damaged or metal part is exposed. Look for cracks or missing plastic.**
- 1 **Be careful when working above 30V rms, 42V ac rms and 60V DC. Such voltages pose a shock hazard.**
- 1 **Discharge all loading of circuit under test after measuring high voltage.**
- 1 **Do not change battery when the Meter is in wet environment.**
- 1 **Place test leads in proper input terminals. Make sure all the test leads are firmly connected to the Meter's input terminals. Make sure the Meter is turned off when opening the battery compartment.**

### **Caution**









- 1 **When performing resistance tests, remove all power from the circuit to be measured and discharge all the power.**

- 1 **When servicing the Meter, use only the same model number or identical electrical specifications of test leads and power adaptor.**
- 1 **Do not use the Meter if the battery indicator (  ) shows a battery empty condition. Take the battery out from the Meter if it is not used for a long time.**
- 1 **Do not use or store the Meter in an environment of high temperature, humidity, explosive, inflammable and strong magnetic field. The performance of the Meter may deteriorate after dampened.**
- 1 **Soft cloth and mild detergent should be used to clean the surface of the Meter when servicing. No abrasive and solvent should be used to prevent the surface of the Meter from corrosion, damage and accident. Dry the Meter before storing if it is wet.**

## International Electrical Symbols

International symbols on the Meter and in this manual are explained in Table 2.

Table 2. International Electrical Symbols

	Risk of electric shock
	Equipment protected by double or reinforced insulation.
	DC Measurement
	AC Measurement
	Grounding
	See Manual
	Empty of Built-In Battery
	Conforms to Standards of European Union



### Battery Saver (Sleep Mode)





The Meter enters the Sleep Mode and blanks the display if there is no button press for 15 minutes. This is done to conserve battery power. The Meter comes out of Sleep Mode when **ON/OFF** button is pressed two times.

The 15 minutes timer is disabled during any insulation resistance measurement. The time period starts immediately following any measurement.

### Battery Indication

There is a battery indicator shows on the display upper left hand corner. Below Table 3 is the explanation:

Table 3. Battery Indication

Battery Indicator	Battery Voltage
	8.5V or less. It means the battery is empty, don't use the Meter as it cannot guarantee accuracy.
	8.6V~9.0V. It means the battery is nearly empty, replacing battery is necessary. Accuracy will not be affected.
	9.1V~10.2V
	10.3V or more

### The Meter Structure

Below Figure 1 and Table 4 shows the Meter front structure and description

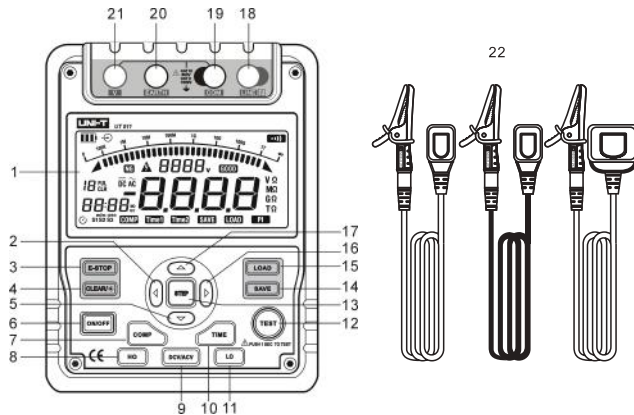

Figure 1. The Meter Front Structure

Table 4. Meter Front Description

1	LCD	12	Test Button
2	◀ Scroll Button	13	Step Button
3	Emergency stop	14	Data Store Button.
4	Data Clear the Display Backlight Button,	15	Data Recall Button
5	▼ Down Button	16	▶ Scroll Button
6	On/Off Button	17	▲ Up Button
7	Compare Button	18	LINE: Resistance input terminal
8	Insulation Resistance Button	19	COM: Voltage input terminal
9	Voltages measurement Button	20	EARTH: Resistance input terminal
10	Timer Button.	21	V: Voltage input terminal
11	Low Resistance measurement Button	22	Testing leads

Below Figure 2 and Table 5 shows the Meter side structure and description

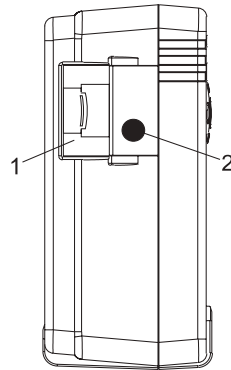

Figure 2. The Meter Side Structure (Side View)

Table 5. Meter Side Description

1	Safety Shutter
2	Power adaptor Input Terminal

### Display

Table 6 and Figure 3 describe the display.

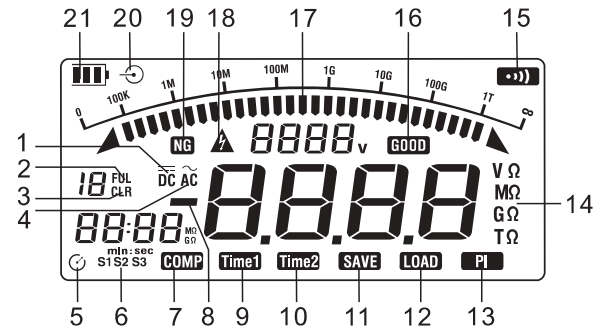

Figure 3. Display

Table 6. Display Description

Number	Meaning	Number	Meaning
1	Indicator for DC voltage	12	Data recall is on
2	Indicator for data store full	13	Indicator for polarization index
3	Indicator for clearing	14	Unit symbols
4	Indicator for AC voltage	15	The continuity buzzer is on
5	Indicator for timer	16	Compare feature pass
6	Step symbol	17	Analogue bar graph
7	Indicates selected pass/fail compare value	18	Risk of electric shock
8	Indicates for negative reading	19	Compare feature fail
9	Timer 1 symbol	20	Indicator for power adaptor
10	Timer 2 symbol	21	Battery life indicator
11	Data store is on		

### Key Functions

Table 7. Key Description



<b>ON/OFF</b>	Turn on or off the Meter. Press and hold the button for 1 second to turn the Meter on.		<ul style="list-style-type: none"> <li>1 Under insulation resistance measurement mode: press to select one voltage range up.</li> <li>1 Under load mode: press to recall the previous stored value.</li> </ul>
<b>CLEAR/☀</b>	Press to clear the stored data, Push 1 SEC to turn on and off the display backlight.		<ul style="list-style-type: none"> <li>1 Under insulation resistance measurement mode: press to select one voltage range down.</li> <li>1 Under load mode: press to recall the next stored value.</li> </ul>
<b>SAVE</b>	Press to store the current measurement value. The maximum number of stored reading is 18. When the stored readings memory is full, the Meter shows FULL and stop storing. Press <b>CLEAR</b> to clear the stored value in order to store the next measurement value.		<ul style="list-style-type: none"> <li>1 When set the timer duration for the measurement of insulation resistance or polarization index, press to decrement the time. The maximum length of time is 30 minutes, the Meter will automatically carry out measurement.</li> </ul>
<b>LOAD</b>	<ul style="list-style-type: none"> <li>1 Press once to recall the first stored value.</li> <li>1 Press again to exit Load feature.</li> <li>1 Load feature can only be used when there is no high voltage output.</li> </ul>		

Table 7. Key Description

◀	<ol style="list-style-type: none"> <li>1 When compare feature measuring insulation resistance, press to decrement a resistance comparing value.</li> <li>1 After polarization index measurement, press to display polarization index, TIME 2 insulation resistance value and TIME 1 insulation resistance value in sequence.</li> </ol>	▶	<ol style="list-style-type: none"> <li>1 After polarization index measurement, press to display polarization index, TIME 2 insulation resistance value and TIME 1 insulation resistance value in sequence.</li> </ol>
▶	<ol style="list-style-type: none"> <li>1 When set the timer duration for the measurement of insulation resistance or polarization index, press to increment the time. The maximum length of time is 30 minutes, the Meter will automatically carry out measurement.</li> <li>1 When use the compare feature measuring insulation resistance, press to increment a resistance comparing value.</li> </ol>	<b>STEP</b>	<p>Press to display S1 → S2 → S3 in sequence.</p> <ol style="list-style-type: none"> <li>1 When the Meter is under timed measurement or polarization index measurement:               <ul style="list-style-type: none"> <li>➢ S1 means increment of 1, then each press of ▶ increase 1 or ◀ decrease 1.</li> <li>➢ S2 means increment of 10, then each press of ▶ increase 10 or ◀ decrease 10.</li> <li>➢ S3 means increment of 30, then each press of ▶ increase 30 or ◀ decrease 30.</li> </ul> </li> </ol>

Table 7. Key Description

<b>STEP</b>	<p>1 When the Meter is under compare mode:</p> <ul style="list-style-type: none"> <li>➤ S1 means increment of 1, then each press of ► increase 1 or ◀ decrease 1.</li> <li>➤ S2 means increment of 10, then each press of ► increase 10 or ◀ decrease 10.</li> <li>➤ S3 means increment of 100, then each press of ► increase 100 or ◀ decrease 100.</li> </ul>
<b>COMP</b>	Set a pass / fail limit for insulation tests. The default value is 100MΩ
<b>TIME</b>	Pres to step through continuous measurement, timed measurement and polarization index measurement in sequence.
<b>TEST</b>	Press to stop or start an insulation resistance test
<b>Ho</b>	Press to initiate insulation resistance measurement

<b>Lo</b>	Press to initiate low resistance measurement
<b>DVC /ACV</b>	Pres to initiate voltages measurement
<b>E-STOP</b>	Emergency stop button. Press this button when the Meter is hang and cannot turn off the power.

### Measurement Operation

Below section explains how to make measurements.

#### A. Measuring Voltages

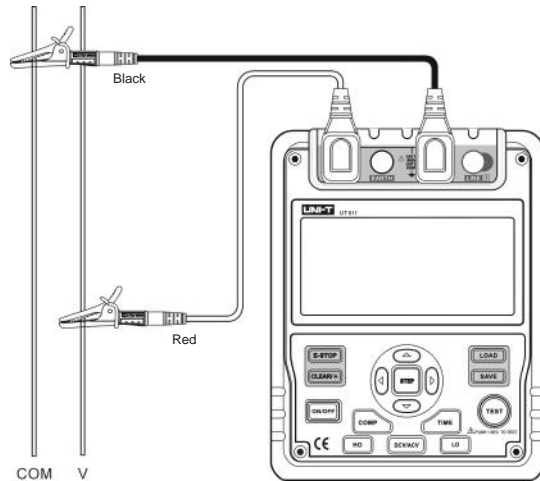

Figure 4. Voltages Measurement

#### ⚠ Caution

- 1 Special care should be taken when measuring high voltage.

#### ⚠ Warning

- 1 To avoid harms to you or damages to the Meter, please do not attempt to measure voltages higher than 1000V DC or 750V AC, although readings may be obtained.

To measure voltages, set up the Meter as Figure 4 and do the following:

1. Press **DCV** or **ACV** button to select DC voltage or AC voltage measurement
2. Insert the red test lead into the **V** terminal and the black test lead into the **COM** terminal.
3. Connect the red and black alligator clip to the circuit to be measured.
4. During measurement, when the red test lead is negative voltage, then “-“ shows on the display.



### Note

- 1 When voltage measurement has been completed, disconnect the connection between the testing leads and the circuit under test and remove testing leads away from the input terminals of the Meter.

### B. Measuring Insulation Resistance

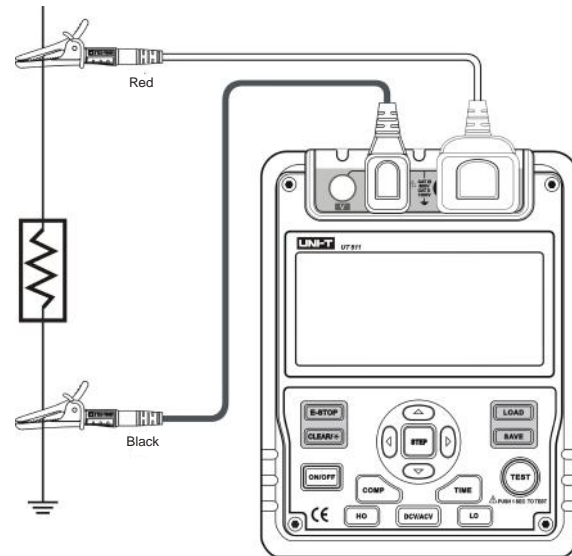

Figure 5. Insulation Resistance Measurement

 **Caution**

- 1 **When performing insulation resistance tests, remove all power from the circuit to be measured and discharge all the power.**
- 1 **Do not short circuit two test leads under high voltage status.**
- 1 **Do not measure insulation resistance after high voltage output.**
- 1 **Do not measure over 10 seconds when:**
  - 100V measure resistance lower than 500k $\Omega$
  - 250V measure resistance lower than 1M $\Omega$
  - 500V measure resistance lower than 2M $\Omega$
  - 1000V measure resistance lower than 5M $\Omega$
- 1 **When the measurement is completed, don't touch the circuit as the circuit has already stored capacitance which may cause electric shock.**
- 1 **Don't touch the test leads even after it has been removed from the circuit until voltages are all released.**

To measure insulation resistance, set up the Meter as Figure 5 and do the following:

1. Press **HO** button to select insulation resistance measurement.
2. Press **▲** and **▼** button to select voltages of 100V, 250V, 500V or 1000V.
3. Insert the red test lead into the **LINE** terminal and the black test lead into **EARTH** terminal.
4. Connect the red and black alligator clip to the circuit to be measured, positive voltage output from **LINE** terminal.
5. Choose below insulation resistance measurement mode.

**a) Continuous Measurement**

- 1 Press **TIME** button to select continuous measurement mode, there is no timer icon on the LCD.
- 1 Press and hold **TEST** button for 1 second to carry out continuous measurement. Output insulation resistance testing voltage, **TEST** button light up, blinks  on every 0.5 seconds.

- Press **TEST** button to close the insulation resistance measurement voltage when measurement is completed. **TEST** button lights off  $\triangle$ , disappears. The LCD shows the current insulation resistance measurement value.

### **b) Timed Measurement**

- 1 Press **TIME** button to select timed measurement mode, the LCD displays **TIME 1** and  $\text{U}$  symbols.
- 1 Press  $\blacktriangleleft \blacktriangleright$ , and **STEP** buttons to set the time (00:05~29:30).
- 1 Then press and hold **TEST** button for 1 second to carry out timed measurement. **TIME 1** and  $\triangle$  are displayed and blinked on the LCD on every 0.5 seconds.
- 1 When the set time is reached, the insulation resistance measurement voltage will be closed and the measurement will be automatically stopped. The LCD displays the insulation resistance reading.

### **c) Polarization Index (PI) Measurement**

- 1 Press **TIME** button to select timed measurement mode, the LCD displays **TIME 1** and  $\text{U}$  symbols.
- 1 Press  $\blacktriangleleft \blacktriangleright$ , and **STEP** buttons to set the time (00:05~29:30).
- 1 Press **TIME** button again. **TIME 2**, **PI** and  $\text{U}$  symbols appear on the LCD.
- 1 Press  $\blacktriangleleft \blacktriangleright$ , and **STEP** buttons to set the time (00:10~30:00).
- 1 Then press and hold **TEST** button for 1 second to carry out timed measurement.
- 1 **TIME 1** and  $\triangle$  are displayed and blinked on the LCD on every 0.5 seconds before **TIME 1** set time is reached.
- 1 **TIME 2** and  $\triangle$  are displayed and blinked on the LCD on every 0.5 seconds before **TIME 2** set time is reached.
- 1 When the two set time are reached, the insulation resistance measurement voltage will be closed and the measurement will be automatically stopped. The LCD displays the polarization index reading.

## Model UT511: OPERATING MANUAL

- 1 Press ◀ ▶ , to set through the polarization index, **TIME 2** insulation resistance reading and **TIME 2** insulation resistance reading.

Information:

PI = 3 minutes ~10 minutes reading / 30 second ~1 minutes reading

PI	4 or more	4~2	2.0~1.0	1.0 or less
Standard	The best	Good	Warning	Bad

### d) *Compare Function*

- 1 Press **COMP** button to select compare feature. **COMP** symbol displays on the LCD.
- 1 Press ◀ ▶ , and **STEP** buttons to set the compare value. The minimum value is 1M The maximum value is the maximum tested voltage allowable measurement value.
- 1 Press and hold **TEST** button for 1 second to carry out the measurement.
- 1 The **NG** symbol will display if the insulation resistance value is smaller than resistance value. Otherwise **GOOD** symbol will be displayed.

### C. Low Resistance Measurement

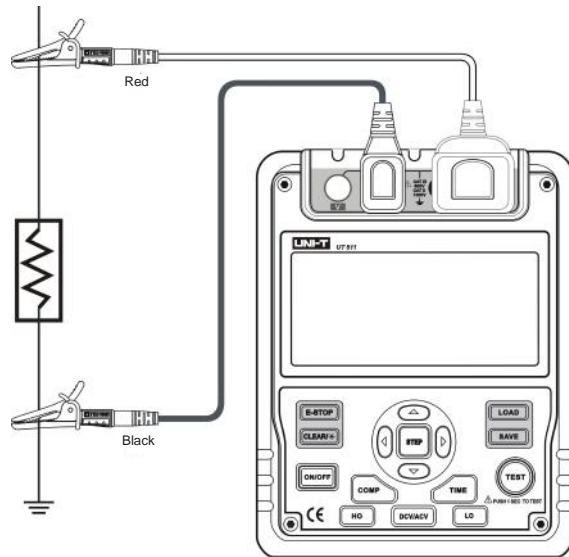

Figure 6. Low Resistance Measurement

### ⚠ Caution

1. **When performing insulation resistance tests, remove all power from the circuit to be measured and discharge all the power.**

To measure low resistance, set up the Meter as Figure 6 and do the following:

1. Press **LO** button to select low resistance measurement..
2. Insert the red test lead into the **LINE** terminal and the black test lead into **EARTH** terminal.
3. Connect the red and black alligator clip to the circuit to be measured. When the resistance is less than 30 the buzzer sounds.
4. This range can test LED diode. Connect the anode LED diode to the red test lead, the LED diode will light up if it is good. If the LED diode does not light up, it means it is damaged.

### The Use of Power Adaptor

The use of power adaptor, see figure 7

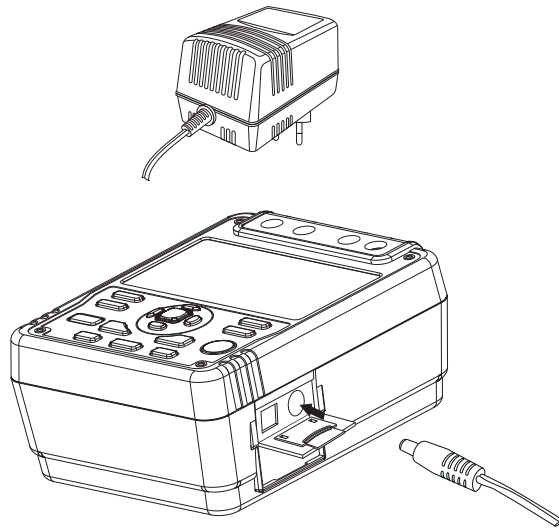

Figure 7. The Use of Power Adaptor

1. Open the side safety shutter, then you will see there is a power adaptor input terminal.
2. Make sure the Meter is power off and Insert the UT511 power adaptor to the input terminal.
3. It is highly recommended to take out all the batteries when you are using the power adaptor.
4. Make sure the Meter is power off when you disconnect the UT511 power adaptor from the Meter. (Input voltage 230VAC, Frequency 50/60Hz, Input current 50mA, Output voltage DC 15V, MAX current 600mA)

#### **Caution**

If you want to choose power adaptor for power supply, please use special power adaptor SA48-150060EU which supported by our company, otherwise it will be dangerous.

## Maintenance

This section provides basic maintenance information including battery replacement instruction.

### Warning

**Do not attempt to repair or service your Meter unless you are qualified to do so and have the relevant calibration, performance test, and service information.**

#### A. General Service

- 1 Periodically wipe the case with a damp cloth and mild detergent. Do not use abrasives or solvents.
- 1 To clean the terminals with cotton bar with detergent, as dirt or moisture in the terminals can affect readings.
- 1 Turn the Meter to OFF when it is not in use.
- 1 Take out the battery when it is not using for a long time.
- 1 Do not use or store the Meter in a place of humidity, high temperature, explosive, inflammable and strong magnetic field.
- 1 If the Meter is wet, dry it before use.

#### B. Replacing the Battery

### Warning

**To avoid electric shock, remove all the test leads from the Meter when replacing the batteries.**

### Caution

- 1 **Don't mix to use old and new batteries.**
- 1 **Be careful the polarity is correct when installing batteries.**
- 1 **Do not use the Meter if the battery indicator (  ) shows a battery empty condition.**

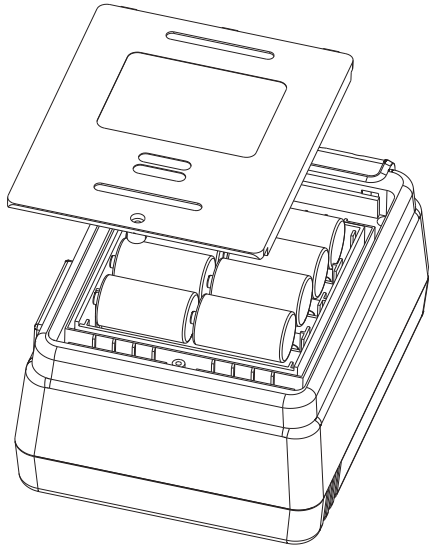

Figure 8. Battery Replacement

Follow Figure 8 and proceed as follows to replace the battery:

- 1 Turn the Meter to OFF and remove all connections from the terminals.
- 1 Remove the screw from the battery compartment, and separate the battery compartment from the case bottom.
- 1 There are 8pcs of 1.5V (R14) carbon batteries in the meter, except this, it can support 1.5V (LR14) alkaline batteries and the special power adapter which our company provided.
- 1 Rejoin the case bottom and battery compartment, and reinstall the screw.



### Specifications

#### Safety and Compliances

Certification	CE
Compliances	IEC 61010 CAT.II 1000V, CAT.III 600V overvoltage and double insulation standard

#### Physical Specifications

Display (LCD)	Digital: 9999 counts    Analog bar graph.
Operating Temperature	-10°C~40°C (14°F~104°F)
Storage Temperature	-20°C~60°C (-4°F~140°F)
Relative Humidity	≤ 85% @ -10°C~40°C below; ≤ 90% @ -20°C~60°C:
Battery Type	8pcs of 1.5V (R14 or LR14) batteries or DC15V power adaptor. DC15V power adaptor is optionally at extra cost.
Dimensions (HxW xL)	202 x 155 x 94 mm
Weight	Approx. 2kg (including battery)

### General Specifications

Range	Auto
Overloading	Display <b>OL</b> on insulation resistance range
Battery Indicator	Display 
Icon Display	Equips with function and battery indicator icons.
Current Consumption	Maximum: around 90mA Average: around 20mA

### Feature Summary

Display Backlight	Bright backlight for clear readings in poorly lighted areas.
Autorange	The Meter automatically selects best range
Warning	 and red light will on.
Voltage	Auto release voltage
COMP Measurement	Use the Compare function to set a pass/fail compare level for the insulation measurements.
PI Measurement	Polarization Index is the ratio of insulation resistance. You can pre-set two point of times and automatically carry out the measurement.

### Detailed Accuracy Specifications

Accuracy:  $\pm$ ([% of reading] + [number of least significant digits]), guarantee for 1 year.

Operating temperature: 18°C ~28°C

Relative humidity: 45~75%RH

#### A. Voltage Measurement

	DC Voltage	AC Voltage
Measurement Range	$\pm 30 \sim \pm 1000V$	30V~750V (50/60Hz)
Resolution	1V	
Accuracy	$\pm(2\%+3)$	30~100V $\pm(2\%+5)$ 100~750V $\pm(2\%+3)$

#### B. Insulation Resistance Measurement

Output Voltage	100V	250V	500V	1000V
Display Range	0.1M $\Omega$ ~99.9M $\Omega$ 100~500M $\Omega$	0.5M $\Omega$ ~99.9M $\Omega$ 100~999M $\Omega$ 1.00~1.99G $\Omega$	1M $\Omega$ ~99.9M $\Omega$ 100~999M $\Omega$ 1.00~3.99G $\Omega$	2M $\Omega$ ~99.9M $\Omega$ 100~999M $\Omega$ 1.00~10.00G $\Omega$
Open Circuit Voltage	DC100V + 20%, -0%	DC250V + 20%, -0%	DC 500V + 20%, -0%	DC1000V + 20%, -0%
Test Current	1mA~1.2mA @ 100k $\Omega$	1mA~1.2mA @ 250k $\Omega$	1mA~1.2mA @ 500k $\Omega$	1mA~1.2mA @ 1M $\Omega$
Short Circuit	Around 2.0mA			
Accuracy	100k $\Omega$ to 100M $\Omega$ : $\pm(3\%+5)$ 100M $\Omega$ above: $\pm(5\%+5)$			

 **Caution**

At any output voltage, when the tested resistance is less than  $5M\Omega$ , the testing time cannot exceed 10 seconds.

**C. Low Resistance Measurement**

Function	Resistance
Measurement Range	$0.1\Omega\sim 999.9\Omega$
Resolution	$0.1\Omega$
Accuracy	$\pm(1\%+3)$
Maximum open circuit voltage	Around 2.8V
Buzzer	Open at less than $30\Omega$
Overload Protection	220V rms/10 seconds

**\*END\***

This operating manual is subject to change without notice.

©Copyright 2006 Uni-Trend Group Limited.  
All rights reserved.

Manufacturer:  
Uni-Trend Technology (Dongguan) Limited  
Dong Fang Da Dao  
Bei Shan Dong Fang Industrial Development District  
Hu Men Town, Dongguan City  
Guang Dong Province  
China  
Postal Code: 523 925

Headquarters:  
Uni-Trend Group Limited  
Rm901, 9/F, Nanyang Plaza  
57 Hung To Road  
Kwun Tong  
Kowloon, Hong Kong  
Tel: (852) 2950 9168  
Fax: (852) 2950 9303  
Email: [info@uni-trend.com](mailto:info@uni-trend.com)  
<http://www.uni-trend.com>